

General Purpose Robot Arm for Industry Use

**ZERO**

---

**Delta Robot Safety Guide**

Document Number: M-0303-220210

February 2022

---



Thank you for your purchase of the general-purpose industrial robot "ZERO"



- Using this product requires "the special education on industrial robots", "qualifications for electrical work", knowledge and skills for robots and a programming language "Python".
  - For safe and proper use of the product, please read the product manuals carefully.
  - Product specifications are subject to change without notice (due to potential future product improvement initiatives).
- 
- We recommend keeping the product manuals handy at all times for easy access.
  - The contents of this document are subject to change without notice.
  - Reproducing or coping the information contained herein, in whole or in part, without prior approval of ZEUS CO., LTD is strictly prohibited.



# Table of Contents

- 1. Compliance .....4
  - 1. Purpose and Use ..... 4
  - 2. Laws and Regulations Concerning Industrial Robots ..... 5
  - 3. Integrator and User Responsibilities ..... 6
  - 4. Environmental Requirements for Operation..... 7
- 2. Safety Signs .....8
- 3. Safety Initiatives .....10
  - 1. Safety Initiatives..... 10
  - 2. Protective Measure for Safety ..... 13
  - 3. Residual Risk in Each Stage of Using the Robot..... 15
    - 1. All Stages ..... 15
    - 2. Unpacking, Carrying, and Mounting ..... 17
    - 3. Installation ..... 18
    - 4. Check before operations ..... 20
    - 5. Teaching..... 22
    - 6. Automatic Operation..... 23
    - 7. Inspection and Maintenance ..... 25
    - 8. Troubleshooting ..... 26
- 4. Safety Measures .....27
  - 1. Creating a Safe Operating Procedure (SOP)..... 27
  - 2. Security fence ..... 36
  - 3. Safety Training on Industrial Robots ..... 38
- 5. Maintenance and Inspection .....40
  - 1. Daily Checkup ..... 41
  - 2. Periodic Inspection..... 44
- 6. Compliance with International Standards .....45
- 7. Export Control .....46
- 8. Warranty and Disclaimer .....47
  - 1. Warranty ..... 47
  - 2. Disclaimer of Liability ..... 50
- 9. Declarations and Certificates.....51



# 1. Compliance

## 1. Purpose and Use

This product is intended for industrial use in order to improve productivity.

It is one of industrial robots which assume only qualified users who completed the training program stipulated by the Occupational Safety and Health Regulations in Japan (or the applicable regulations in the country concerned). For safe use of the product, read all manuals carefully and comprehend them.

To build a safe system, observe the precautions described herein and conduct a risk assessment under conditions of actual service.

The safety precautions described in the product manuals pertains to this product only.

Those precautions do not necessarily cover the entire system which this product is integrated to.

Take adequate safety measures for the entire system, not only for this product.

## Compliance



### 2. Laws and Regulations Concerning Industrial Robots

Industrial robots must be installed and operated in compliance with the safety requirements set forth in the standards and regulations of the country concerned.

In Korea, The laws and regulations concerning occupational safety and health from "Ministry of Employment and Labor" are listed below. Keep up with any updates in the applicable laws and regulations.

- ① Occupational Safety and Health Act
- ② Enforcement Decree of the Occupational Safety and Health Act
- ③ Enforcement Rules of the Occupational Safety and Health Act
- ④ Safety and technology guidelines for the use of industrial robots
- ⑤ Occupational Safety and Health Education Regulations
- ⑥ Rules on Occupational Safety and Health Standards
- ⑦ Notification of autonomous safety verification of hazardous machinery and equipment

Source of Acquisition : Korea Occupational Safety and Health Service

URL : <https://www.kosha.or.kr/>

400, Jongga-ro, Jung-gu, Ulsan, 44429, Republic of Korea ,

Customer Service Center +82 52-7030-500

# Compliance



## 3. Integrator and User Responsibilities

In this document, manufacturer, integrator and user are defined as follows.

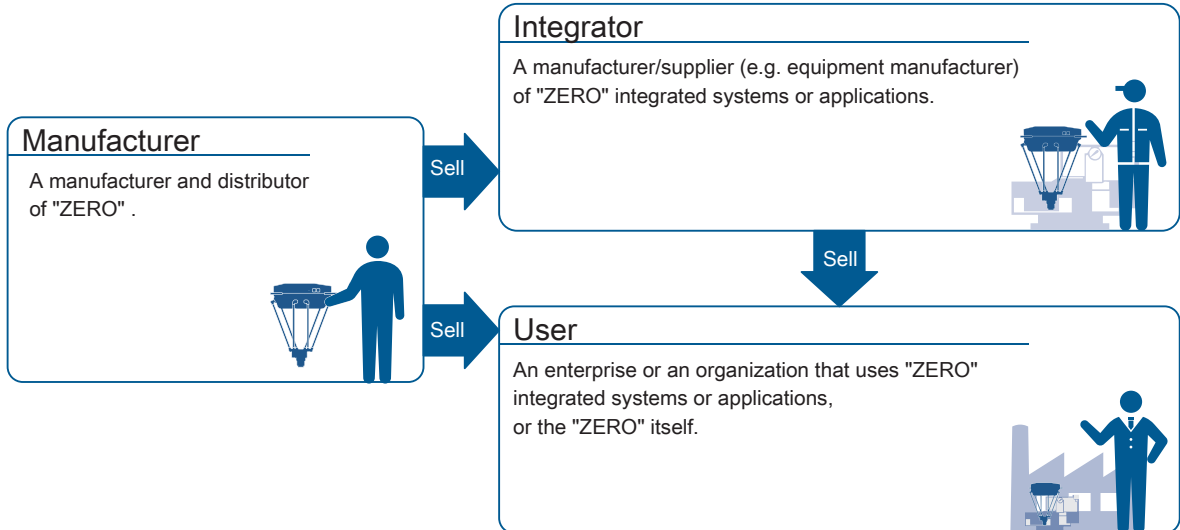

For safe use of the product, adequate preparation and proper use are essential.

**Product Manuals** Please read all the product manuals carefully and fully understand them.

We recommend that the users of this product keep all of the guides and manuals about the system and the safe operating procedure (safe work procedure statement) handy at all times for easy access.

**Risk Assessment & Safety Measures**

Always conduct a comprehensive risk assessment on the overall system.

Repeat the risk assessment followed by risk reduction measures until your safety goal is met (i.e. the acceptable level of residual risk).

Verify and validate that the safety measures taken during the risk assessment work well on the overall system.

The safety configuration should not be easily modified by anyone but the administrator.

**Safe Operating Procedure (SOP)**

Create a safe operating procedure for the entire system.

In the SOP, include clear step-by-step instructions for procedures in each phase and hazards associated with them. Ensure awareness of the SOP to all personnel.

When creating a standard operating procedure, incorporate expertise and latest information from relevant personnel such as integrators, labor safety consultants, and our customer service.

When any changes have been made to the system, immediately reevaluate the SOP and update it if necessary.

Build an emergency response system and create an emergency contact list including the integrator for prompt response in the event of emergency.

If the system has been built by both the user and the integrator, responsibilities of each party and division of liabilities must be clearly defined in the documentation.



# Compliance

## 4. Environmental Requirements for Operation



Observe the following requirements for proper use of the product.

Item	Specification
Operating ambient temperature	0° C ~ 40° C (non-condensing)
Operating humidity	30% ~ 85% (non-condensing)
Storage temperature	- 25° C ~ 70° C (non-condensing)
Storage humidity	10% ~ 95% (non-condensing)
Operating atmosphere	Indoor use only (no direct sunlight) Good ventilation Free from corrosive gases, flammable gases, oil mist, any liquids including water, dust, flammables, and grinding agent No noise source such as high voltage equipment and electric devices in proximity No explosives, no explosive ambience, and no flammable gas in proximity No heat source such as a heating appliance in proximity
Vibration and Impact Load	Vibration during operation: 0.5 G or less (no excessive vibration or shock) Controller: JIS B3502 compliant Manipulator: -
Degree of Protection	IP40 compliant (Manipulator tool attaching point, Controller) / IP20 ( Manipulator upper part )
Pollution Degree	2
Overvoltage Category	II
Power Supply Voltage	Connect the controller to a power supply protected by an earth-leakage circuit breaker. 1) Voltage fluctuations within the range of input voltage; within +/- 10% of the rated voltage 2) No voltage sag for longer than 20 ms Secure adequate power source supply including inrush current.
Grounding	Ground resistance of 100 Ω or less (JIS Class D grounding)
Electromagnetic Noise	No strong electric or magnetic field in proximity 1) No noise of over 1000 V and over 1 μs pulse width. 2) No large inverters, high output of high-frequency transmitter, large contactor or welding equipment in proximity.
Static Electricity	No contact discharge of over 4 kV. No air discharge of over 8 kV.
Radiation	Not significantly larger than the typical allowable exposure to humans.
Atmospheric Pressure	No higher than 1000 meters above sea level; Not in vacuum pressure.
External Disturbance Magnetic Fields	Within ± 2 mT
Safety Category	3 (The overall system cannot be Category 4)
Cleanroom Classification	Only the clean type can be used in a clean room.
Emergency Stop Switches	B contact (normally closed). Use a product compliant with applicable standards such as IEC60947-5-5.





## 2. Safety Signs

This manual uses the signs below to indicate serious but avoidable problems caused by misuse of the product. One is for death or serious bodily harm and the other is for bodily injury or product or equipment damage.

 <b>Danger</b>	Identifies information about imminent hazards that will result in "Death or Serious injury".
 <b>Caution</b>	Identifies information about hazards that could result in "Injury or Equipment damage".

Throughout this document, the safety precautions that users must follow are marked as follows.

	Safety Precaution - "Prohibited Action"
	Safety Precaution - "Mandatory Action"

Possible hazardous events are marked as follows.

	<u>Cautions and Dangers</u> Causes unpredicted, unstable, or uncontrolled motions. Compromises the performance or reliability of the product and shortens the product life.
	<u>Electric shock hazard</u>
	<u>Burn hazard</u>
	<u>Fire hazard</u>
	<u>Injury hazard</u>
	<u>Failure and damage hazard</u>
	<u>Collision hazard</u>
	<u>Trip and fall hazard</u>



## Safety Signs







Warning labels are located on the manipulator and the controller. For safe use of the product, observe the precautions on the warning labels.

Do not peel, modify, or damage the warning labels.

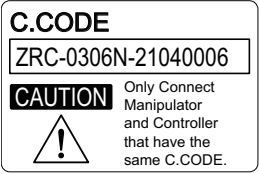
Do not cover the warning labels with other devices in the system. Always keep the labels visible.

Secure adequate lighting for the signs and characters on the warning labels to be visible from outside the safety fence.

 <b>Danger</b>	
	<p><u>C.CODE Label</u></p> <p>Check the C.CODE labels on the manipulator and the controller. Connect only a C.CODE-matching pair of the manipulator and the controller to each other. Wrong manipulator-controller connections can cause unpredicted movements.</p>
	<p><u>Hazardous Voltage Label</u></p> <p>The power outlet has a high-voltage component which can cause electric shock. Never disassemble the controller. After the controller is powered off, it takes more than 30 minutes for the internal voltage to completely discharge. Meanwhile, do not touch the controller.</p>
	<p><u>Collision Warning Label</u></p> <p>Warns you of potential collision hazards. If there is a need to enter the manipulator's work envelope, confirm the safety before performing the task.</p>
	<p><u>Pinch Warning Label</u></p> <p>Warns you of pinch point hazards at the manipulator joints. If there is a need to enter the manipulator's work envelope, beware of movements of the joints as well as the tip of the manipulator.</p>



### 3. Safety Initiatives

#### 1. Safety Initiatives

Industrial robots are dangerous because of their large work envelope, high-speed arm movements, and their demand for tasks such as teaching. In addition, human errors during operation or influence of noise may create risk for robot malfunction.

Use this safety guide to build a highly reliable, safe system appropriate for user's work environment.



Take ample measures for safety and provide workers with adequate safety training, in order to prevent accidents, bodily injuries, and property damages.

An industrial robot is an "automatically controlled, reprogrammable, multipurpose manipulator, which can be either fixed in place or mobile for use in industrial automation applications."

- Those robots demand expertise and skills of users because of their complex and sophisticated control system.
- They may malfunction because of external factors such as noise depending on installation conditions.
- They are dangerous because their high-speed, complex movements are almost impossible to follow.

To use this product safely, please implement the following.

1. Use of the product with plenty room from the specification limits and redundant configuration of the overall system.
2. Multiple-layer safety design including fail-safe to minimum hazards in case of failure or malfunction, and foolproof to prevent failures and malfunctions.
3. Safety design of the overall system in order to prevent hazards and alert users.
4. Verification of safety with periodic inspections and maintenance of the system.
5. Risk assessment under user's operating environment.
6. Comprehensive risk assessment for the overall system.

	<p>Do not enter the work envelope of the robot during operation.</p>
	<p>As a general rule, perform a task such as teaching from outside the work envelope.</p> <p>If there is a need to enter the work envelope, do not stand under the manipulator or between the wall and the manipulator to avoid caught-in/between hazards. In case of malfunction or operation error, be ready to press one of the emergency stop switches at any moment when needed.</p> <p>To perform a task such as inspection, stop the robot movement first.</p> <p>If there is a need to perform a task while the robot is in motion, do so from outside the work envelope.</p>



## Safety Initiatives

### Potential risk of the robot body itself

It is mandatory for the integrator (any supplier of "ZERO" applications) and the user to perform risk assessment sufficient for the product according to the applicable safety regulations and take appropriate safety measures.

The ZERO robot has the following risks that the integrator and the user must take into account.

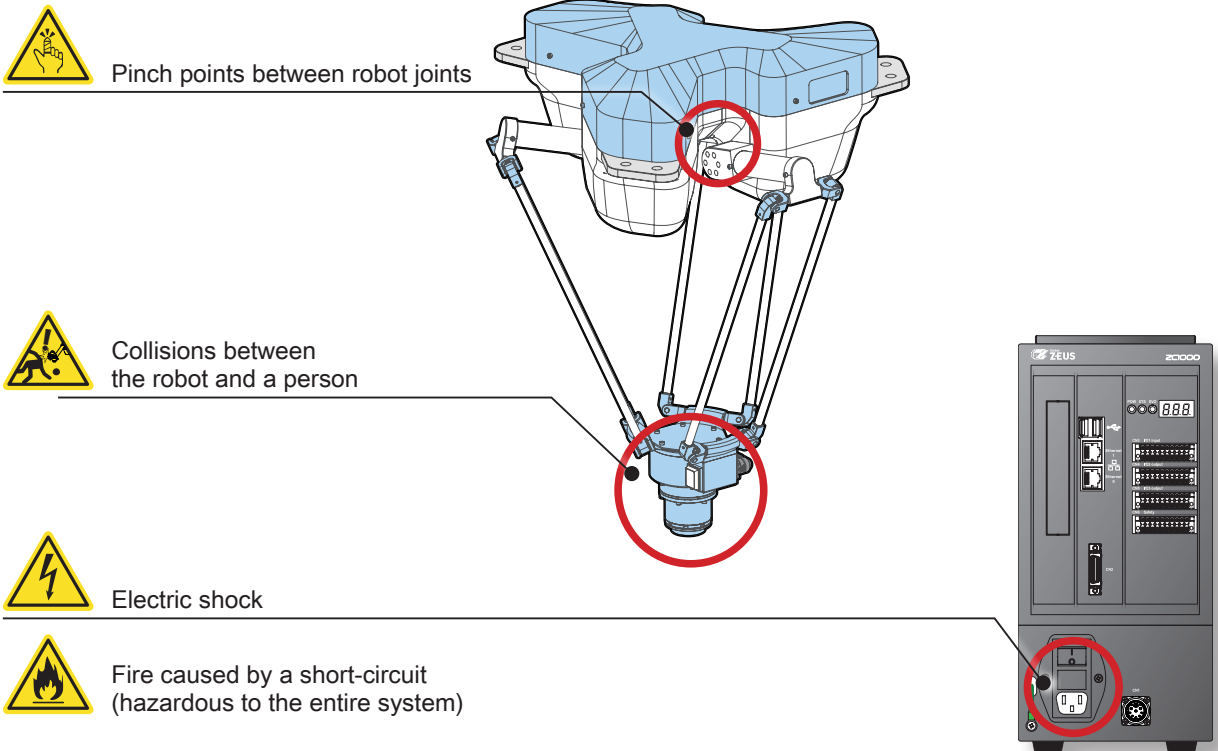

In addition, there are potentially significant hazards which the integrator and the user must take into account. These include, but are not limited to:

- Penetration of skin by sharp edges or sharp points on tool or tool connector
- Penetration of skin by sharp edges or sharp points on obstacles near the robot track
- Workpiece drop due to a poor grip of end-effector or power interruption
- Mistakenly using an emergency stop button which is intended for equipment other than the robot



## Danger



The operation mode switch must not be accessible to any personnel other than teaching operators. It is dangerous to let anybody besides teaching operators access the operation mode switch by, for example, placing the controller outside the safety barriers.



## Safety Initiatives



### Emergency Stop

Install emergency stop switches to shut down the entire system instantaneously.

In case of emergency, use the emergency stop switch to stop the manipulator safely.

Emergency stop shall not be used as a risk reduction measure, but as a secondary protective device. Use emergency stop switches that comply with applicable standards such as IEC60947-5-5 and observe the precautions for those products.

### Releasing the Brake in an Emergency

In case of emergency, you can manually release the brake of any manipulator joint and move the manipulator.

	<p>Do not enter the area under the arm when releasing the brake. Ensure that there are no people in the robot's range of operation. The arm may drop under its own weight when you release the brake manually</p>	
	<p>If there is potential hazard such as interference with surroundings, take a non-hazardous position and release the brake.</p>	

### How to release the brake

Connect the controller and the manipulator using the manipulator cable, and turn on the power to the controller. Power to the robot becomes present. Note that the brakes cannot be released unless the robot is powered on. To release a brake, press the brake release button located at each joint.

#### Brake Release Button

The robot brakes could not be turned off when it has no power.

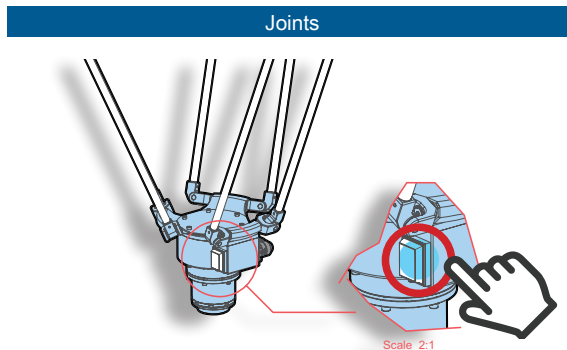

The brake releases while pressing the brake release button.

### Connecting the Peripheral Equipment



## Caution

The peripheral equipment must be within the rated voltage and current ranges.

Connecting unrated equipment can cause controller damage.  
For more information, refer to the Robot User's Guide.

# Safety Initiatives



## 2. Protective Measure for Safety



Protective measures for safety are described below. Those are minimal requirements. We recommend implementing appropriate protective measures suitable for user's environment.

### Safe Operating Procedure (SOP)



Develop a safe operating procedure before using this product. Create a SOP describing step-by-step instructions on tasks involved in the use of this product and the entire system including the peripheral equipment and devices, starting from safety management through the final step of disposal.

Make the SOP available to all involved so that they will know exactly what to do during both normal and abnormal operations.

Your SOP documentation should cover the "3. Residual Risk in Each Phase" described in the next section.

### Personal Protective Equipment



Safety Helmet



Safety Glasses



Gloves



Easy-To-Work Clothing anti-static



Safety Shoes



Worker













Do not wear loose clothing, jewelry, necktie, or strap to avoid caught-in hazards.







## Safety Initiatives

### Facilities

	<b>Lockout</b> Install a lockout key for the power switch of the controller.
	<b>Safety barriers</b> Provide a safeguarded area (with a fence) rigid enough to keep workpieces contained and withstand collisions.
	<b>Interlock</b> Install an interlock system to be synchronized with the operation of the overall system.
	<b>Tagout</b> Implement a tagout mechanism at the gate of the safeguarded area.
	<b>Warning lights</b> Install warning lights (aka: stack lights, indicator lights, signal tower lights, etc.) that will be visible from anywhere on-site.
	<b>Emergency Stop Switches</b> Install emergency stop switches inside the safeguarded area. In addition, prepare portable emergency stop switches for workers including a watchdog.
	<b>Sound alarm</b> Install a sound alarm system to assure that all workers on site can be alerted even in noisy environment.
	<b>Storage for the JOG stick, teaching pendant and the jumper connector</b> Store the JOG stick, teaching pendant and the jumper connector in a locked cabinet. Make it impossible to change the operation mode easily.
	<b>Protection of the safety system</b> The safety system in place should be not easily modified by anyone but the administrator.
	<b>Status display</b> Post status display plates at key places such as the control panel/the controller, and the gate of the safety fence.
	<b>Protective grounding</b> Ensure protective grounding.
	<b>Insulation</b> Insulate the device.

### Signals and systems

	<b>Signals</b> Establish a signaling method of hand gestures, gestures, or flag signals that can work well even in noise.
	<b>Supervisor and System Administrator</b> Appoint a person to be in charge of system-wide control.
	<b>Confirmation and Monitoring</b> Never fail to confirm. Be sure to place a watchdog.
	<b>Safe Operating Procedure (SOP), Task Assignments and Record Keeping</b> Assign roles and tasks to each of the personnel, so that each person can focus only on the assigned tasks. Keep a record of tasks performed.















# Safety Initiatives



## 3. Residual Risk in Each Stage of Using the Robot

1. All Stages   2. Unpacking, Carrying   3. Installation   4. Check before o   5. Teaching   6. Automatic Oper   7. Inspection and   8. Troubleshooting









### 1. All Stages

Hazardous Situation	Preventive Measures
<p>Teaching of the robot by operator lacking completed industrial robot training - creating risk for personal injury or property damage.</p> 	<p>Be sure that all operators complete industrial robot training in accordance with the applicable national law.</p> <ul style="list-style-type: none"> <li>Do not allow unqualified personnel to be involved.</li> <li>Display the name of a person in charge of each system and do not allow others to have access.</li> <li>Keep a record of the training program offered and a list of certified or qualified persons' names for at least 3 years.</li> </ul> 
<p>Safety barriers not installed - creating risk for personal injury or property damage.</p> 	<ul style="list-style-type: none"> <li>Install a safety fence around the work envelop to isolate the manipulator.</li> <li>Operate the robot from outside the fence.</li> <li>Establish a safe work procedure in details in case that there is a need to enter the safety fence. (Do not turn your back to the robot. Do not stand under the arm.)</li> </ul> 
<p>Delay in emergency response due to a safety management system not well-established - creating risk for delayed emergency response</p> 	<ul style="list-style-type: none"> <li>Establish a safety management system, determine roles, and create an emergency phone tree, which should be available to everyone.</li> </ul> 
<p>Workers not wearing personal protective equipment - creating risk for personal injury.</p> 	<ul style="list-style-type: none"> <li>Wear adequate personal protective equipment such as a helmet, safety glasses, safety shoes and gloves, and protect yourself from impact hazards.</li> </ul> 
<p>A worker wearing loose items such as a strap, tie, or jewelry leading to a caught-in hazard - creating risk for personal injury.</p> 	<ul style="list-style-type: none"> <li>Do not wear loose items which could get caught in.</li> <li>Tie your long hair back.</li> </ul> 
<p>Status signs not displayed - creating risk for personal injury or property damage</p> 	<ul style="list-style-type: none"> <li>Install equipment such as alarm signal light, tagout, sound alarms, status display, etc.</li> <li>Make everyone know what each status display means.</li> </ul> 
<p>Signaling between operators not well-established or not clear - creating risk for personal injury or property damage.</p> 	<ul style="list-style-type: none"> <li>Establish a method to signal between the operators and the watchdog.</li> </ul> 



# Safety Initiatives

1. All Stages   2. Unpacking, Carrying   3. Installation   4. Check before o   5. Teaching   6. Automatic Ope   7. Inspection and   8. Troubleshooting

Hazardous Situation	Preventive Measures
<p>Appropriate use of protection features, key storage and operation method not well-enforced - creating risk for personal injury.</p> 	<ul style="list-style-type: none"> <li>• Display the descriptions of protection features of the interlock and lockout systems and explain them to the workers.</li> <li>• Prevent anyone except the system administrator from changing the safety mechanism.</li> <li>• Store the JOG stick, teaching pendant and the jumper connector in a locked location, so that no one can change the operation mode easily.</li> </ul> 
<p>Manipulator malfunction due to noise caused by an unexpected electronic device present in the work area - creating risk for personal injury or property damage.</p> 	<ul style="list-style-type: none"> <li>• Prohibit to bring in electronic devices which can cause noise. Post a sign such as "No Electronic Devices Allowed".</li> </ul> 
<p>Working alone - creating risk for personal injury.</p> 	<ul style="list-style-type: none"> <li>• Employ a "buddy system".</li> <li>• The watchdog is responsible for monitoring the process closely. If a potentially problematic or hazardous situation arises, he shall halt the operation with the emergency stop switch.</li> </ul> 
<p>Unauthorized help on the task - creating risk for personal injury or property damage.</p> 	<ul style="list-style-type: none"> <li>• Always report to the manager before starting to help, and receive instructions from the manager.</li> </ul> 













# Safety Initiatives

- 1. All Stages
- 2. Unpacking, Carrying
- 3. Installation
- 4. Check before operation
- 5. Teaching
- 6. Automatic Operation
- 7. Inspection and
- 8. Troubleshooting

## 2. Unpacking, Carrying, and Mounting

Hazardous Situation	Preventive Measures
<p><b>Manipulator</b></p> <p>Improper unpacking of the manipulator - creating risk for personal injury or property damage.</p> 	<p>When removing the manipulator from the cardboard box:</p> <ol style="list-style-type: none"> <li>1) Do not hold the resin part.</li> <li>2) Two or more people must work together.</li> </ol> 
<p><b>Moving the Robot to the Installation Site</b></p> <p>Drop/fall of the robot - creating risk for personal injury or property damage.</p> 	<ul style="list-style-type: none"> <li>• Use a trolley or dolly to move the product to the installation site.</li> <li>• Implement the buddy system. Hold the product with both arms wrapped around the bottom.</li> </ul> 
<p><b>Mounting the Robot Controller</b></p> <p>Drop of the robot - creating risk for personal injury or property damage.</p> 	<ul style="list-style-type: none"> <li>• Hold the controller with both arms wrapped around the bottom.</li> <li>• Do not wear loose items such as a tie, strap, or jewelry.</li> <li>• Be careful not to apply an excessive force to the protrusions such as the switches, terminal blocks, connectors, or cooling fan.</li> </ul> 
<p><b>Mounting the manipulator</b></p> <p>Drop/fall of the manipulator during temporary mounting work on the mount table or the like - creating risk for personal injury or property damage.</p> 	<ul style="list-style-type: none"> <li>• Always two or more people must work together.</li> <li>• Hold the manipulator with both arms wrapped around the bottom.</li> <li>• Be sure to fix it temporarily with more than one fixing bolts.</li> <li>• Do not wear loose items such as a tie, strap, or jewelry.</li> </ul> <p>Hold the controller without applying excessive force to protrusions such as connectors.</p> <p>Install the manipulator and peripherals in places where they will be always visible to the operator.</p> <ul style="list-style-type: none"> <li>• Install the manipulator correctly, taking into account items such as mounting angles, the weight of end-effector, offset eccentricity and safety configuration.</li> <li>• Select an installation location such that the manipulator will not reach any heads of operators.</li> </ul> 
<p><b>Mounting the manipulator</b></p> <p>Drop/fall of the manipulator during temporary mounting work on the mount table or the like - creating risk for personal injury or property damage.</p> 	<ul style="list-style-type: none"> <li>• Always two or more people must work together.</li> <li>• Hold the manipulator with both arms wrapped around the bottom.</li> <li>• Be sure to fix it temporarily with more than one fixing bolts.</li> <li>• Do not wear loose items such as a tie, strap, or jewelry.</li> </ul> <p>Hold the controller without applying excessive force to protrusions such as connectors.</p> <p>Install the manipulator and peripherals in places where they will be always visible to the operator.</p> <ul style="list-style-type: none"> <li>• Install the manipulator correctly, taking into account items such as mounting angles, the weight of end-effector, offset eccentricity and safety configuration.</li> </ul> <p>Select an installation location such that the manipulator will not reach any heads of operators.</p>



# Safety Initiatives

- 1. All Stages
- 2. Unpacking, Carrying
- 3. Installation
- 4. Check before o
- 5. Teaching
- 6. Automatic Oper
- 7. Inspection and
- 8. Troubleshooting















## 3. Installation

Hazardous Situation	Preventive Measures
<p><b>Installation of Safety Fence</b></p> <p>No safeguarding system installed - creating risk for personal injury.</p> <div style="display: flex; justify-content: space-around; margin-top: 10px;"> </div>	<ul style="list-style-type: none"> <li>Do not turn on the main power until a safeguarding enclosure for the work envelope is complete.</li> <li>Use rope or chain barriers around the work envelope in lieu of permanent safety fence. The poles must be steady. Post a sign for temporary barriers at a easily-seen location. Do not let the workers enter the work envelope.</li> <li>Install a permanent safety fence prior to production operation.</li> </ul> <div style="text-align: center; margin-top: 10px;"> </div>
<p><b>Installation of the Controller and the Control Panel</b></p> <p>The controller operation from where safety check of inside the safety fence is not feasible - creating risk for personal injury or property damage.</p> <div style="display: flex; justify-content: space-around; margin-top: 10px;"> </div>	<ul style="list-style-type: none"> <li>Install startup equipment for the controller and the control panel outside the safety fence.</li> <li>Install the controller at a place where the operator can confirm that there is no one inside the safety fence.</li> <li>Install the controller at a place where the operator can always see the manipulator, peripheral equipment and devices.</li> </ul> <div style="text-align: center; margin-top: 10px;"> </div>
<p><b>Installing the Manipulator</b></p> <p>Setup of all peripherals not completed when operation begins - creating risk for personal injury or property damage.</p> <div style="display: flex; justify-content: space-around; margin-top: 10px;"> </div>	<ul style="list-style-type: none"> <li>Allow only a certified electrician to work on installation. Do not allow uncertified personnel to be involved.</li> <li>Secure an adequate service space around the robot and peripheral equipment for teaching, maintenance, and inspection.</li> </ul> <div style="text-align: center; margin-top: 10px;"> </div>
<p><b>Connection of the Primary Power Supply</b></p> <p>Electric shock during wiring work of the primary power supply Robot failure due to wrong power supply voltage</p> <div style="display: flex; justify-content: space-around; margin-top: 10px;"> </div>	<ul style="list-style-type: none"> <li>Allow only certified electricians to perform the wiring task.</li> <li>Apply tagout/lockout. Do not turn on the power until all wiring and connections are confirmed.</li> <li>The task sequence of confirming of the primary power off first, starting of wiring next must be strictly observed.</li> <li>Double-check the voltage and current ratings of the peripheral equipment to be connected.</li> </ul> <div style="text-align: center; margin-top: 10px;"> </div>
<p><b>Connection of the Primary Power Supply</b></p> <p>Error during robot operation.</p> <div style="display: flex; justify-content: space-around; margin-top: 10px;"> </div>	<ul style="list-style-type: none"> <li>Secure stabilized power supply and adequate capacity and adopt uninterruptible power supply equipment.</li> <li>Mark the power switch names in order to indicate which switch belongs what device. Do not leave any confusion.</li> </ul>
<p><b>Connecting the Controller and the Manipulator</b></p> <p>A wrong pair of manipulator and controller (having C.CODEs different from each other) becoming connected - creating risk for property damage.</p> <div style="display: flex; justify-content: space-around; margin-top: 10px;"> </div>	<ul style="list-style-type: none"> <li>C. CODE is unique to each pair of controller and manipulator and is different from other pairs even among the same model.</li> <li>Make sure to connect the right pair of manipulator and controller of the same C. CODE with each other.</li> </ul> <div style="text-align: center; margin-top: 10px;"> </div>



# Safety Initiatives

- 1. All Stages
- 2. Unpacking, Carrying
- 3. Installation
- 4. Check before o
- 5. Teaching
- 6. Automatic Ope
- 7. Inspection and
- 8. Troubleshooting













Hazardous Situation	Preventive Measures
<p><b>Wiring and Connections</b></p> <p>Wiring not completed upon power on - creating risk for electric shock, short circuit, or ground fault.</p> 	<ul style="list-style-type: none"> <li>Do not turn on the power until work completion is reported from the certified electrician assigned to the task.</li> <li>Be sure to connect PE (protective earth).</li> <li>Prior to wiring power supply, be sure to turn off the upstream circuit breaker in order to prevent electric shock.</li> <li>Be sure to insulate conductive parts with insulating materials.</li> </ul>  
<p><b>Wiring and Connections</b></p> <p>Manipulator malfunction due to disconnection of cable or damage to piping - creating risk for property damage or error.</p> 	<ul style="list-style-type: none"> <li>Do not apply excessive force (e.g., pulling, stepping on, vending too much) to cables, connectors or air pipes .</li> <li>Protect them with cover or piping if necessary</li> <li>Tighten the connector fixing screws and the fixing mechanism.</li> <li>Tie cables of user tooling and air piping together whenever needed and fix them in place, in order to avoid restricted motions of robot due to the cables and air piping becoming entangled or wrapped around the robot.</li> </ul>
<p><b>Wiring and Connections</b></p> <p>Wiring performed by an uncertified electrician - creating risk for personal injury or property damage.</p>  	<ul style="list-style-type: none"> <li>Select a person to perform wiring from the certified personnel list.</li> <li>Create a list of certified personnel, keep it updated, and disseminate.</li> <li>Identify and document tasks requiring certification/qualification.</li> </ul>  
<p><b>Wiring and Connections</b></p> <p>Grounding not performed - creating risk for electric shock or malfunction due to electrostatic charge, decreased noise resistance, or unnecessary electromagnetic radiation.</p> 	<ul style="list-style-type: none"> <li>Be sure to ground to the location specified in the Robot User's Guide.</li> <li>Let a certified electrician perform the grounding task.</li> <li>Create a safe operating procedure.</li> </ul>  
<p><b>Wiring and Connections</b></p> <p>An emergency stop switch being connected to a general-purpose input - creating risk for malfunction, personal injury or property damage.</p>   	<ul style="list-style-type: none"> <li>Be sure to connect the emergency stop switch to the corresponding terminal CN6 (Safety connector).</li> </ul> 



# Safety Initiatives

1. All Stages 2. Unpacking, Carrying 3. Installation 4. Check before operations 5. Teaching 6. Automatic Operation 7. Inspection and Maintenance 8. Troubleshooting





## 4. Check before operations

Hazardous Situation	Preventive Measures
<p><b>Manipulator</b></p> <p>Manipulator motions not well-thought-out or checked when teaching or automatic operation begins - creating risk for personal injury or property damage.</p> 	<ul style="list-style-type: none"> <li>• Before each operation: confirm that the manipulator is operating normally.</li> <li>• Perform JOG operation to confirm that movements are smooth, and that there is none of abnormal noise, unusual smell, or positional deviations in taught points.</li> </ul> 
<p><b>Cables</b></p> <p>Short-circuiting due to damaged sheath of external wiring or outer sheath - creating risk for short-circuiting leading to property damage.</p> 	<ul style="list-style-type: none"> <li>• Protect the cables with piping or cover when wiring.</li> <li>• Display alert signs for bumps and level differences in order to prevent the workers from tripping and falling.</li> <li>• Confirm that there is no damage or no disconnection, and that all cables are connected securely.</li> </ul> 
<p><b>Checking of Functions</b></p> <p>Malfunction - creating risk for personal injury or property damage</p> 	<ul style="list-style-type: none"> <li>• Before each operation: confirm that all functions work normally.</li> <li>• Before each operation: inspect all equipment and peripheral devices for damage or faulty functioning.</li> </ul> 
<p><b>Emergency Stop Switches</b></p> <p>Emergency stop failure even when the interlock is unplugged - creating risk for personal injury or property damage.</p> 	<ul style="list-style-type: none"> <li>• Confirm that all emergency stop switches work normally. (including the interlock system and the emergency stop switch on the JOG stick)</li> </ul> 
<p><b>Checking of Inside the Safety Fence</b></p> <p>Workers present inside the safety fence when operation begins - creating risk for personal injury.</p> 	<ul style="list-style-type: none"> <li>• Before starting operation: confirm that there is no one in the safeguarded area and no obstructions within the work envelope.</li> </ul> 
<p><b>JOG Stick and Teaching Pendant</b></p> <p>Faulty functioning of the JOG stick and Teaching Pendant due to its body damage - creating risk for personal injury or property damage.</p> 	<ul style="list-style-type: none"> <li>• Inspect the controller, manipulator and JOG stick and teaching pendant for any visible damages possibly causing malfunction. Confirm that they are all operating normally.</li> <li>• If there is any fault or damage, do not use it.</li> </ul> 

# Safety Initiatives



- 1. All Stages
- 2. Unpacking, Carrying
- 3. Installation
- 4. Check before
- 5. Teaching
- 6. Automatic Oper
- 7. Inspection and
- 8. Troubleshooting

Hazardous Situation	Preventive Measures
<p><b>Fixing Mechanism</b></p> <p>Fixing bolts used on the manipulator mount table becoming loosened - creating risk for personal injury or property damage.</p> 	<ul style="list-style-type: none"> <li>Check for any looseness of the bolts and screws and confirm that the manipulator is fixed securely.</li> <li>Be sure that the end-effector is properly secured with bolts in their mounting positions and the workpieces are set at the right position.</li> </ul> 
<p><b>Operation Check of the Entire System</b></p> <p>Collision caused by abnormal functioning of some peripheral devices - creating risk for personal injury or property damage.</p> 	<ul style="list-style-type: none"> <li>Confirm that the entire system operates normally.</li> <li>Conduct a comprehensive risk assessment for the entire system.</li> </ul> 







Safety Initiatives

# Safety Initiatives



- 1. All Stages
- 2. Unpacking, Carrying
- 3. Installation
- 4. Check before o
- 5. Teaching
- 6. Automatic Ope
- 7. Inspection and
- 8. Troubleshooting

## 5. Teaching

Hazardous Situation	Preventive Measures
<p>Teaching Operation (prior to start-up)</p> <p>Safety check not performed prior to start-up - creating risk for personal injury</p> 	<ul style="list-style-type: none"> <li>Display a "Teaching in Progress" sign at the controller and at the entrance of safety fence, in order to prohibit automatic operation.</li> <li>Confirm that tagout is intact.</li> <li>Secure the priority right to control the robot and let the person who enter the safety fence carry the safety plug.</li> <li>Confirm that all emergency stop switches work normally.</li> <li>Confirm that the robot can be stopped immediately in the event of an abnormality.</li> <li>Start the operation only after confirming the work procedures and safety management items.</li> </ul> 
<p>Teaching Operation (inside the safety fence)</p> <p>Human errors inside the safety fence - creating risk for personal injury</p> 	<ul style="list-style-type: none"> <li>Place a watchdog and let him carry an emergency stop switch.</li> <li>Prepare portable emergency stop switches and let any worker entering the safety fence carry one.</li> <li>While working inside the safety fence, the operator must be ready to press the emergency stop switch at any moment when needed.</li> <li>Always keep an eye on the manipulator while teaching the robot.</li> <li>Determine the procedure including all tasks performed inside the safety fence -preparing for teaching through re-enabling the safety mechanism in the end- and enforce it to the operators.</li> <li>During any hazardous operation, all personnel on-site must be alerted.</li> </ul> 
<p>Teaching Operation (inside the safety fence)</p> <p>Operation inside the safety fence lacking adequate safety protection measures - creating risk for personal injury or property damage.</p> 	<ul style="list-style-type: none"> <li>Perform teaching from outside the safety fence as much as possible.</li> <li>If there is a need to enter the safety fence, be sure that all protective measures have been taken in order to prevent hazards foreseen at the risk assessment.</li> <li>Be sure to include the protective measures in the SOP and enforce them.</li> </ul> 



# Safety Initiatives

- 1. All Stages
- 2. Unpacking, Carrying
- 3. Installation
- 4. Check before c
- 5. Teaching
- 6. Automatic Operation
- 7. Inspection and
- 8. Troubleshooting





## 6. Automatic Operation

Hazardous Situation	Preventive Measures
<p><b>Start-up</b></p> <p>Safety check not performed prior to start-up - creating risk for personal injury or property damage.</p>	<ul style="list-style-type: none"> <li>Comply with "Technical Guidelines on Safety Standards for Use of Industrial Robots 4-3-1" in Japan or the applicable safety standards in the country concerned.</li> <li>Abide by the task sequence described in the SOP.</li> </ul>
<p><b>During Operation - Overwork</b></p> <p>Work exceeding the specified value of rated load - creating risk for property damage or error.</p>	<ul style="list-style-type: none"> <li>Prohibit non-integrator personnel to make any change to the system.</li> <li>Design the system such that the total mass (including user tool, hand, and workpiece) will be within the rated load.</li> <li>The user tool must have adequate gripping force for the workpiece.</li> <li>An eccentric tool must be designed such that it will be within the allowable torque.</li> </ul>
<p><b>During Operation - Dumped Workpiece</b></p> <p>Workpiece gripped by the end-effector becoming dumped upon power off - creating risk for personal injury or property damage.</p>	<ul style="list-style-type: none"> <li>Configure the system such that the open/close status of hand will not change upon power off. For example, use double-solenoid hand</li> <li>In case of a workpiece becoming dumped, design and configure safeguarding such that dumped workpieces will be contained inside the safety fence. Collisions and emergency stops can release high level of kinetic energy - significantly higher at high speeds or with high payloads.</li> </ul>
<p><b>During Operation - Electrostatic Adsorption Equipment</b></p> <p>Malfunction due to workpieces statically charged - creating risk for property damage or error.</p>	<ul style="list-style-type: none"> <li>Insulate the hand and the manipulator</li> <li>Configure the system such that the charge of statically charged workpiece will be discharged through an appropriate route, so that the device receiving the charged workpiece will not malfunction.</li> </ul>
<p><b>During Operation - JOG Stick or Teaching Pendant Not Connected</b></p> <p>Emergency stop failure due to an inactive e-stop means (use of unconnected Jog stick or teaching pendant) - creating risk for personal injury or property damage.</p>	<ul style="list-style-type: none"> <li>When you are not using the JOG stick or teaching pendant, store it in a lockable cabinet outside the safety fence and indicate that it is not functioning as an emergency stop switch.</li> </ul>

# Safety Initiatives



1. All Stages 2. Unpacking, Carrying 3. Installation 4. Check before c 5. Teaching 6. Automatic Operation 7. Inspection and 8. Troubleshooting

Hazardous Situation	Preventive Measures
<p>During Operation - Safety Fence</p> <p>Emergency stop failure due to the safety fence gate malfunction - creating risk for personal injury or property damage.</p> 	<ul style="list-style-type: none"> <li>• Confirm that the interlock mechanism of the safety fence gate is intact.</li> <li>• Be sure to place a watchdog so that he can trigger an emergency stop whenever necessary.</li> <li>• Confirm that tagout is intact.</li> <li>• Enforce the operator to carry the safety plug when entering the safety fence.</li> <li>• Follow the response measures in the event of an abnormality.</li> <li>• Do not allow anyone to enter the safety fence during automatic operation.</li> <li>• Design the safeguarding structure such that only the entrance/exit allow an entry from outside the safety fence.</li> </ul> 
<p>During operation - Synchronization with Peripheral Devices</p> <p>Sudden power supply shutdown due to an emergency stop or power outage - creating risk for property damage.</p> 	<ul style="list-style-type: none"> <li>• In the work cell layout, provide ample clearance to the peripheral devices that operate in synchronization with the robot.</li> <li>• When designing the system, take into account that the robot might not stop immediately because of inertia.</li> </ul>
<p>Entering the Safety Fence</p> <p>Careless entry to the work envelope of the manipulator - creating risk for personal injury.</p> 	<ul style="list-style-type: none"> <li>• Enforce no entry other than through the designated entrance/exit.</li> <li>• Reinforce the lock mechanism of the safety fence with multiple layers (tagout, interlock, light curtains, etc.). (*)</li> </ul> 

\*) If you are to use interlocks or light curtains, be sure that the safeguarding system will conform to applicable safety standards such as IEC61496.















# Safety Initiatives

- 1. All Stages
- 2. Unpacking, Carrying
- 3. Installation
- 4. Check before c
- 5. Teaching
- 6. Automatic Ope
- 7. Inspection and
- 8. Troubleshooting

## 7. Inspection and Maintenance

Hazardous Situation	Preventive Measures
<p><b>Maintenance Work</b> (inspection, repair, cleaning, etc.)</p> <p>The power switch not locked out - creating risk for personal injury Caution sign "Maintenance (inspection, repair, cleaning) in Progress" not displayed - creating risk for personal injury.</p> 	<ul style="list-style-type: none"> <li>Configure the system such that no maintenance tasks can be performed unless the main power supply is shutoff and the power switch is locked.</li> <li>Configure the system such that only the person carrying the lockout key can hold the priority to control the robot.</li> <li>Enforce displaying a status sign such as "Inspection in Progress" on the controller and at the safety fence gate. Create a mechanism that allows no entry unless such a sign is displayed.</li> <li>Release the tagout, carry the safety plug with you, then enter the safeguarded area.</li> </ul> 
<p><b>Inspection</b></p> <p>Faulty functioning of the manipulator or the system - creating risk for property damage.</p> 	<ul style="list-style-type: none"> <li>Confirm that safety devices such as emergency stop device work as they should.</li> <li>Confirm that there is no damage or malfunction that can lead to abnormal operation. If any abnormality is recognized, take an action to resolve it immediately.</li> <li>After inspection or any system change, always test run the robot and confirm that it works normally.</li> </ul> 
<p><b>Inspection</b></p> <p>Release of stored energy after power off - creating risk for personal injury such as burn or electric shock.</p> 	<ul style="list-style-type: none"> <li>After operation is finished and the power is switched off, the controller and the manipulator must remain untouched, at least 30 minutes for controller discharge and an hour for manipulator heat dissipation. Immediately after operation, the robot body (especially the joints where the motors are built in) may be hot, which can result in a burn hazard.</li> <li>Display a danger sign such as "Heat/Electric Discharge. Do Not Touch".</li> <li>Allow ample time for the residual energy to be released.</li> <li>Enforce personal protective clothes (such as gloves) appropriate for work.</li> <li>Place warning labels such as "Danger - Hot surfaces/High voltage" at hazardous spots.</li> </ul> 
<p><b>Inspection</b></p> <p>Drop under its own weight of the manipulator arm upon brake release - creating risk for personal injury.</p> 	<ul style="list-style-type: none"> <li>Confirm that there is no one, no interference, and no obstacle inside the safety fence.</li> <li>Release the brake only after the robot is put in a posture that will not cause interference with the peripheral equipment.</li> </ul> 
<p><b>Inspection</b></p> <p>Improper procedure to resume operation after inspection - creating risk for personal injury or property damage.</p> 	<ul style="list-style-type: none"> <li>Enforce the right procedure to resume automatic operation.</li> <li>Enforce to check that there are no persons, no interferences, and no obstacles inside the safety fence.</li> </ul> 



# Safety Initiatives

- 1. All Stages
- 2. Unpacking, Carrying
- 3. Installation
- 4. Check before c
- 5. Teaching
- 6. Automatic Ope
- 7. Inspection and
- 8. Troubleshooting

## 8. Troubleshooting

Hazardous Situation	Preventive Measures
<p><b>Immediate Stop in The Case of Abnormality</b></p> <p>No means to halt the operation immediately in the case of an abnormality - creating risk for personal injury or property damage.</p> <div style="display: flex; justify-content: space-around; margin-top: 10px;"> </div>	<ul style="list-style-type: none"> <li>When designing the overall system, place emergency stop switches at easy-access locations in order to be operated at any moment when needed.</li> <li>All involved must check the locations of emergency stop devices and switches together.</li> <li>Prepare portable emergency stop switches for troubleshooting workers to carry.</li> <li>Place a watchdog and let him carry an emergency stop switch.</li> <li>Always check, before each work, that the emergency stop switch functions as it should.</li> </ul> <div style="display: flex; justify-content: space-around; margin-top: 10px;"> </div>
<p><b>Immediate Stop in The Case of Abnormality</b></p> <p>Unable to stop a peripheral machine operating along with the robot - creating risk for personal injury or property damage.</p> <div style="display: flex; justify-content: space-around; margin-top: 10px;"> </div>	<ul style="list-style-type: none"> <li>Design a safety system that will stop the related equipment synchronized with the robot all together.</li> <li>Design the work cell such that workers can perform their tasks without turning their backs to the peripheral equipment as well as the manipulator.</li> <li>Before each work, always check that emergency stop switches function as they should.</li> </ul> <div style="display: flex; justify-content: space-around; margin-top: 10px;"> </div>
<p><b>Error Processing and Logging</b></p> <p>Manipulator still in motion when approached by a worker trying to collect error log - creating risk for personal injury.</p> <div style="display: flex; justify-content: space-around; margin-top: 10px;"> </div>	<ul style="list-style-type: none"> <li>When you are to approach the manipulator or the controller to collect error log in the case of error, confirm first that the robot is completely stopped.</li> <li>Be sure to place a watchdog and let him focus on monitoring the process closely.</li> <li>The safety plug must be carried by the person who enters the safety fence.</li> <li>Be prepared with the error log, the model name, and serial number, and contact the customer service.</li> </ul> <div style="display: flex; justify-content: space-around; margin-top: 10px;"> </div>
<p><b>First Response</b></p> <p>Abnormality response procedure not well-established - creating risk for personal injury or property damage.</p> <div style="display: flex; justify-content: space-around; margin-top: 10px;"> </div>	<ul style="list-style-type: none"> <li>Adhere to the work procedure.</li> <li>Determine in advance a reporting method and what to do in case of abnormality.</li> <li>Configure the system such that the related peripheral devices will be stopped safely.</li> </ul> <div style="display: flex; justify-content: space-around; margin-top: 10px;"> </div>
<p><b>Stopping of the Related Equipment Synchronized with the Robot</b></p> <p>Setup of the robot in case that the related equipment stops abnormally not completed - creating risk for personal injury or property damage.</p> <div style="display: flex; justify-content: space-around; margin-top: 10px;"> </div>	<p>Adhere to the work procedure in case that the related equipment stops because of an external factor such as abnormal voltage.</p> <div style="display: flex; justify-content: space-around; margin-top: 10px;"> </div>

## 5. Safety Measures



### 1. Creating a Safe Operating Procedure (SOP)



At first, read the product manuals carefully to have a good understanding of the product. Create a SOP appropriate for user's industrial robot type, installation environment, and tasks. Share the SOP with all the persons involved.

In creating of a SOP, we recommend incorporating input from the personnel involved, integrators, labor safety consultants, the customer service personnel from all manufacturers (including our company) of your system components.

Creating of a SOP is stipulated by the 【Safety Technical Guidelines for the Use, etc. of Industrial Robots 6.2.1 Working Regulations】 .



- Keep the SOP that you created, along with the product manuals, handy at all times for easy access to the personnel.
- When any changes have been made to the system, immediately re-evaluate the SOP and update it if necessary.
- When you are to relocate, transfer, or resell the robot, please hand over the product manuals along with it.

#### Unpacking

1. Upon unpacking, never pull out the robot by holding the resin cover. If this precaution is not observed, the resin cover may become damaged.
2. If the robot is expected to be relocated, store the packing materials and fixing jigs in a safe place. You will need them for repacking the robot.

#### Carrying the robot

1. Before carrying the robot, check its weight found on the label at the top of cardboard box.
2. Two persons are needed to carry a product of less than 30 kg. Use both hands (wrapping arms around the bottom) to hold and carry the box. If the box has carry handles, be sure to use them.
3. Be careful not to apply excessive impact or vibrations to the product when using a trolley or placing it on a mount table.
4. Be careful not to apply an excessive force to protrusions such as the switches, terminal blocks, connectors, or cooling fan.
5. When transporting the product, pack it in the same way as it was in shipment to you.



## Safety Measures

### Preparing for Installation and Operation (Manipulator and Controller)

1. For temporary mount of the robot on a mount table or stand, fix it with one or more bolts to the mounting holes of the mount base in order to prevent falling of the robot.
2. In addition to securing adequate work space in designing the system, and adequate clearance between the movable part of the robot and its surrounding - to prevent crushing/trapping incidents.  
If setting a home position is necessary, confirm that the robot will have no obstructions in its home setting posture.
3. In installing of the controller and its starter equipment, make sure that the operator can perform safety check of inside the safety fence from his controller operating position. (Use of control device or limit switch in accordance with IEC 60204-1)
4. If the operating areas of multiple manipulators overlap, take measures such as installing an interlock system - to prevent the manipulators from simultaneously entering the common area and interfering with each other.
5. If no safeguarding measures are taken prior to initializing and commissioning of the robot, clearly mark the restricted area in a tentative way in advance.
6. Secure the manipulator and controller to the specified horizontal mount bases with fixing bolts and screws, in order to prevent dislocation and tip-over.  
Make sure that the mount table is strong enough to withstand the weight of robot and reaction forces during operation.
7. Install the controller outside the safeguarded area (outside of the safety fence). Install the controller at a location that facilitates operating of the controller and simultaneously monitoring of the manipulator.  
(The height of the controller platform should be 0.6 m or more for ease of maintenance.)
8. Mount the controller on a horizontal surface. Do not remove the rubber feet.  
Keep the ambient temperature within the specification range, taking into account the ventilation by the air exhaust and intake vents.
9. In mounting of controller, manipulator and peripherals, take into account the space and work procedure for maintenance and repair.
10. Do not place a heavy object on the manipulator or controller. In addition, do not hang on to the manipulator.
11. Do not allow any foreign materials to ingress the manipulator or controller. In particular, conductive foreign materials such as screws and metal pieces, and flammable foreign substances such as oil can cause rupture or damage to the robot.



## Safety Measures

### Preparing for Installation and Operation (I/O connector on the cable)

1. Fix the connector of manipulator cable correctly in the specified way.
2. If necessary, use duct or cover to protect the cables and connectors from excessive force.  
Tighten the connector fixing screws and fixing mechanism firmly.
3. When laying cables and pipes, take adequate safety measures against trip-over or fall hazard. Additionally, be careful not to damage the cables. Display warning signs at hazardous locations.
4. Separate the inter-apparatus cable and the external I/O cable from the power cables and grounding cables of other equipment. External I/O cables must be shielded ones.  
Do not apply to each terminal a voltage higher than the specification value. Failure to observe this precaution can cause rupture or damage.
5. Do not connect wrong terminals to each other. Failure to observe this precaution can cause rupture or damage.
6. Do not mistake one pole for the other pole of a polarity. Failure to observe this precaution can cause rupture or damage.
7. If the manipulator is to glide along a linear track, never use the (rigid) inter-apparatus cable included in shipment, as it can lead to a cable break hazard. Please use a user-supplied flexible cable instead.
8. Prior to connecting the primary power supply cable to the controller, confirm that the voltage of the cable is within the specification range. Connect the cable only to the specified location. During this work, the controller must be switched off.
9. Do not connect or remove any cables or connectors while the power is on.

### End-Effector

1. Confirm that the total weight including the workpiece does not exceed the rated payload.
2. When attaching an eccentric end-effector, make sure that the allowable torque on the wrist will be satisfied.
3. Secure your end-effector with screws of the size specified according to the mounting dimensions of the top flange.  
Make sure that there are no protrusions or sharp corners except for parts that are functionally necessary.
4. When securing cables or hoses to the manipulator, be careful that the robot's movement does not cause the cables or hoses and the manipulator to become entangled. Tangle can damage the manipulator or limit the robot's movement.
5. In case that the end-effector may drop the gripped object while moving, take prevention measures to the grip mechanism in advance.
6. Take preventive measures in advance against hazards due to dropping of the end-effector dumping of the workpiece in the event that the power to the tool is removed.  
If the open/close state of the end-effector needs to be retained even while the power is off, use a double solenoid to make your end-effector.
7. If the end-effector is to grab a workpiece that is being statically charged, insulate the end-effector and the manipulator body. Otherwise, malfunction due to discharge can occur.  
In addition, configure the system that will discharges the charge of statically charged workpiece through an appropriate route, so that the device receiving the charged workpiece will not malfunction.



## Safety Measures

### JOG Stick

1. Before teaching the robot, connect the JOG stick to CN2 on the controller securely. In addition, do not pull or bend its cable excessively.
2. After teaching is complete, remove the JOG stick from the controller in order to prevent inadvertent operation. For other operations except for teaching, connect a jumper connector to CN2 on the controller.

### Teaching Pendant

1. Before teaching the robot, connect the JOG stick to CN2 and Ethernet port on the controller securely. In addition, do not pull or bend its cable excessively.
2. After teaching is complete, remove the JOG stick from the controller in order to prevent inadvertent operation. For other operations except for teaching, connect a jumper connector to CN2 on the controller.
3. Do not use external power adapter terminals and USB terminals when operating the manipulator using the teaching pendant.

### Grounding

1. Be sure to ground properly at the location specified in the Robot User's Guide.  
Grounding is mandatory for safe use of the product and essential to prevent electric shock, or electrostatic charge, improve noise resistance performance, and suppress unnecessary electromagnetic radiation.
2. Use a wire with a diameter specified for grounding, and make the distance from the grounding point as short as possible.
3. The grounding of the robot must be dedicated one - being separated from the grounding system of other large equipment.

### Emergency Stop

1. Install an E-stop switch in an easy-access safe location near the manipulator in the safeguarded area and connect it to the external E-stop terminal on the controller.  
(Normally closed B contact type with a mechanical locking function; a product conforming to the safety standards)
2. In addition, install E-stop switches to safeguarding equipment such as safety fence gates, and install an interlock mechanism so that those safety devices will stop the manipulator in emergency.
3. In the case of a system which includes machinery synchronizing with manipulator operation, the system should be designed such that an E-stop switch simultaneously shuts down the related equipment as well.

### Stop by Software

1. Install a stop switch in an easy-access location near the robot and connect it to the external I / O terminal on the controller.
2. Do not use the stop switch as a safeguarding device such as a safety fence gate.  
Install an emergency stop switch in a safeguarding device.
3. Do not enter the safeguarded area (the safety fence) while the robot is in a "stop" state by software.



## Safety Measures

### Status Display

1. Make sure that the robot operation status (e.g., operating by program, stop state, error state) can be easily recognized from outside the safeguarded area by using indicator lamps or the like.  
Use the specific external I/O signals prepared in the controller.
2. In the event of an abnormality, use the sound and light alarms to assure that all workers in the vicinity are alerted.  
In particular, make sure that appropriate warning signals will be output in the case of a hazard due to a failure during unsupervised machine operation.

### Power Off

- 1.. Provide means to manually shut off all power supplies to the system from outside the safety fence.
- 2.. The shutoff position on the operating device such as a lever on the shutoff unit must be easily recognized.  
Clearly indicate which part of the machine is shut off by the power shut off.
- 3.. Take measures such as use of a lockout key in order to prevent inadvertent operation.
- 4.. When the manipulator is powered off, the arm may drop under its own weight depending on the postures. In case that this can cause a hazard such as interference with peripheral devices, turn off the power only after making the manipulator in a posture which can avoid the hazard.
- 5.. After the manipulator becomes powered off, the end-effector may slightly drop before the brake is engaged.  
In case that this can cause a hazard such as interference with peripheral devices, turn off the power only after making the manipulator in a posture which can avoid the hazard.

### Power On

1. Before turning on the power, make sure that there is no one in the safeguarded area (inside the safety fence).  
In addition, conform that unnecessary tools or devices are not left there.
2. Confirm that there are no visible abnormalities, for example, damage, disconnection, or looseness of cables, hoses and connectors.
3. Check that target workpieces, peripheral devices, and jigs are at their specified initial positions.  
In addition, confirm that turning on the power to peripheral devices does not cause hazardous movements.
4. In case that some power-on sequence to each device in the system may become hazardous, determine a safe power-on sequence and perform a task following the prescribed procedure.  
(Observe the same precaution in the power off procedure as well.)
5. After turning on the power, operate the emergency stop switches and confirm that they all work normally.  
After turning on the power, operate the safety protection devices and check that they all work normally.
6. Jog the robot at reduced speed first, and confirm that the manipulator satisfies the motion restricted space of each joint.



## Safety Measures

### Teaching and Programming

1. Perform teaching from outside the safeguarded area (outside the safety fence) as much as possible.  
If there is a need to perform a task in the safeguarded area, be sure to follow all instructions described in the SOP.  
The SOP must include the following items.
  - 1) Procedures and tasks for the manipulator operation  
(specifying operators, procedure to temporarily disable the safety protective equipment, etc.)
  - 2) Manipulator speed during the operation  
(in principle, JOG stick and teaching pendant operation only; automatic operation is prohibited)
  - 3) How to signal between multiple workers
  - 4) Recovery procedure in the event of an abnormality
  - 5) Preventive measures for hazards caused by human errors
2. Prior to teaching in the safeguarded area (inside the safety fence), always secure the priority to control the system.
3. The operation mode depends on what is connected to CN2 on the controller. To teach or jog a robot, connect the JOG stick or teaching pendant to the controller so that automatic operation becomes disabled.
4. Turn on the enable switch of the JOG stick or teaching pendant only when you want to operate the manipulator for teaching.
5. The movements of all synchronized equipment in the safeguarded area (inside the safety fence) must be disabled; or must be controlled only by the teaching operator.
6. A watchdog must be available to halt the operation immediately, in case of abnormality during teaching operation.  
All workers besides the operator of teaching also need to carry a portable emergency stop switch each.
7. Create an environment that facilitates teaching operation with adequate lighting and other means.
8. The operator of teaching should wear easy-to-work clothing and personal protective equipment such as safety shoes and a helmet. Other trap-prevention measures include tying the long hair and not wearing loose items such as strap or tie.
9. The operator needing to be in the safeguarded area (in the safety fence) must secure an exit route without turning his back to the manipulator in case of emergency.
10. User-programs and all changes made to them should be read out and saved to an external storage such as a personal computer.
11. After teaching is complete, reactivate any safety protective devices that have been temporarily disabled and restore them to their original functions.

### Test Run

1. After teaching and programming, test-run the robot with stepwise operation and then reduced speed operation before proceeding with automatic operation.
2. During test run in the safeguarded area (inside the safety fence), follow the safe work procedure determined in advance along with teaching operation.
3. In the case that peripheral devices start up synchronizing to the robot by I/O signals in test run, observe their movements carefully.  
In the same way as the teaching operation, the movements of all synchronized equipment in the safeguarded area (inside the safety fence) must be disabled; or must be controlled only by the teaching operator.
4. When conducting test run in the midst of the program, be careful not to cause interference with peripheral devices.
5. If the program is lengthy or complex, print out the contents and fully understand the program execution order before conducting test run.





## Safety Measures

### Automatic Operation

1. Before starting automatic operation, confirm that there is no one in the safeguarded area (inside the safety fence).  
If visible check for no one present inside is not feasible, an alarm signal must be issued upon start of automatic operation, and anyone exposed to potential risk must be given enough time to operate one of emergency stop switches at any moment.
2. Before starting automatic operation, make sure that all related peripheral devices are ready for automatic operation and there is no indication of abnormality.
3. Be sure to start automatic operation from outside the safeguarded area (outside the safety fence).  
After stopping of the robot in an emergency, resuming of the operation must be done from outside the safeguarded area (outside the safety fence).
4. Prior to automatic operation, confirm that the program selected is indeed for the target task.  
Operate the robot as slow speed as possible through the end of the first cycle. Use the speed override function for the reduced speed operation.
5. If any abnormality is found in the manipulator or peripheral equipment, stop the operation immediately.  
In the case that a new risk may arise due to the stop position or any other reason, adjust the timing to stop the robot accordingly in order to reduce the risk.
6. If the manipulator stops with unknown cause during automatic operation, never approach the stopping manipulator immediately.  
Be sure to trigger an emergency stop or shut off the main power supply.
7. If you need to abort the program and restart it during automatic operation, check that restarting the program will not introduce a new danger to peripheral devices.
8. If you abort the program during automatic operation and then revise the program contents or positional data, be sure to test run before restarting automatic operation.
9. In selecting a different operating speed using the speed override function during automatic operation, make sure that the new speed setting does not create new hazards. (e.g., danger of too fast, or too slow)
10. Use a structure that will prevent the gripped workpiece or any tools from becoming dumped/scattered.  
Take preventive measures in anticipation of the centrifugal force due to arm movement during automatic operation and the impact of sudden stop due to emergency stop.
11. Depending on the posture of the manipulator, the arm will hang down when the robot stops in an emergency or the power is shut off.  
In addition, when the manipulator is moving at high speed, it may not stop immediately because of its inertia.  
Be careful not to let such an event cause dangerous conditions including interference with peripheral devices.
12. If a manipulator collides with a workpiece or peripheral equipment at high speed because of a program errors or other reasons during automatic operation, the workpiece, peripheral equipment, arm, or internal mechanism can become damaged.  
In case of such hazard, conduct a risk assessment and take adequate risk reduction measures to build a safe system.



## Maintenance and Inspection

1. Configure the system which will allow personnel to work from outside the safety protection area (outside the safety fence) as much as possible.  
In case that there is a need to enter the safeguarded area (the safety fence), the system should be configured such that safety for workers can be assured.
2. If working from outside the safeguarded area (outside the safety fence) is not possible and there is a need to enter the safeguarded area, in principle, turn off the power before performing maintenance. In such a case, be careful not to create a new hazard by shutting off the power.
3. If there is a need to work in the safeguarded area (inside the safety fence) without shutting off the power, be sure to secure the priority right to control the system before proceeding.
4. Even after the power is turned off, stored energy in equipment can be hazardous. Take appropriate measures to gradually release stored energy. Stored energy has different forms such as pressurized gases and liquids, charge, spring, counter-balance, flywheel, etc. Identify and label them in advance.
5. The controller includes a high-voltage component which can cause electric shock. Never disassemble the controller.
6. Tagout with alert signs such as "Maintenance in Progress" at required locations, so that the robot cannot be inadvertently controlled by a third party.  
Be sure to place a watchdog, who shall halt the operation immediately with the emergency stop switch in the event of unexpected movement.
7. Be sure to conduct daily check and periodic inspections in accordance with the Robot User's Guide.  
Please contact our related service department for any situation that demands external help.  
Perform system-wide maintenance in accordance with the maintenance plans provided by your integrator.
8. In inspecting of the controller, check the cooling fan for unusual air flow or abnormal noise, and confirm that it is functioning normally.
9. When disengaging any brake, confirm that there is no one within the work envelope. The robot arm may drop under its own weight. If there is a risk of interference with peripheral equipment, put the robot in the posture that will not cause any hazard before releasing the brake.
10. Create an environment that will facilitate maintenance by providing adequate space and lighting.
11. Do not modify the manipulator on your own discretion or use maintenance parts different from the specifications.  
In particular, never modify any of the safety related components such as emergency stop.
12. When restoring the power after maintenance work, confirm that turning on the power will not cause any devices to make hazardous movements.
13. After maintenance work, if there is any safety protection device that has been temporarily disabled, enable it so that it will work as initially intended.  
(For example, reactivate the interlock for the safety fence, etc.)
14. Do not conduct an insulation resistance testing (Megger testing) during inspection.
15. Do not short circuit, charge, heat, incinerate or disassemble the battery.



## Safety Measures

### Troubleshooting

1. In the same way as maintenance, try the following in sequence until you finish the work.

- 1) Troubleshoot from outside the safeguarded area (outside the safety fence)
- 2) Troubleshoot in the safeguarded area (inside the safety fence) while the power is off.
- 3) Troubleshoot in the safeguarded area (inside the safety fence) while automatic operation is disabled.

If there is a need to enter the work envelope, connect the jog stick to the controller in advance to secure the priority to control the system.

2. Tagout with alert signs such as "Inspection in Progress" at required locations, so that the robot cannot be inadvertently controlled by a third party.

Be sure to place a watchdog so that he can halt the operation in the event of unexpected robot movement.

3. The error code displayed on the controller in the event of an abnormality provides an important clue for you to determine the cause of the abnormal condition. Be sure to record the error code and refer to the related part of the Robot User's Guide to resolve the problem.

4. Please contact our service department if you encounter any problem that demands external help.

### Modification

1. Do not modify the manipulator on your own discretion or use maintenance parts different from the specifications. In particular, never modify any of the safety related components such as emergency stop.

2. Defects resulting from customer modification are not covered by the warranty.

### Disposal

1. Dispose of the product as industrial waste.

2. Do not disassemble any parts of the product.

3. Dispose of batteries in accordance with the local regulations.

## Safety Measures

### 2. Security fence

The figure below illustrates an example of a safety fence.

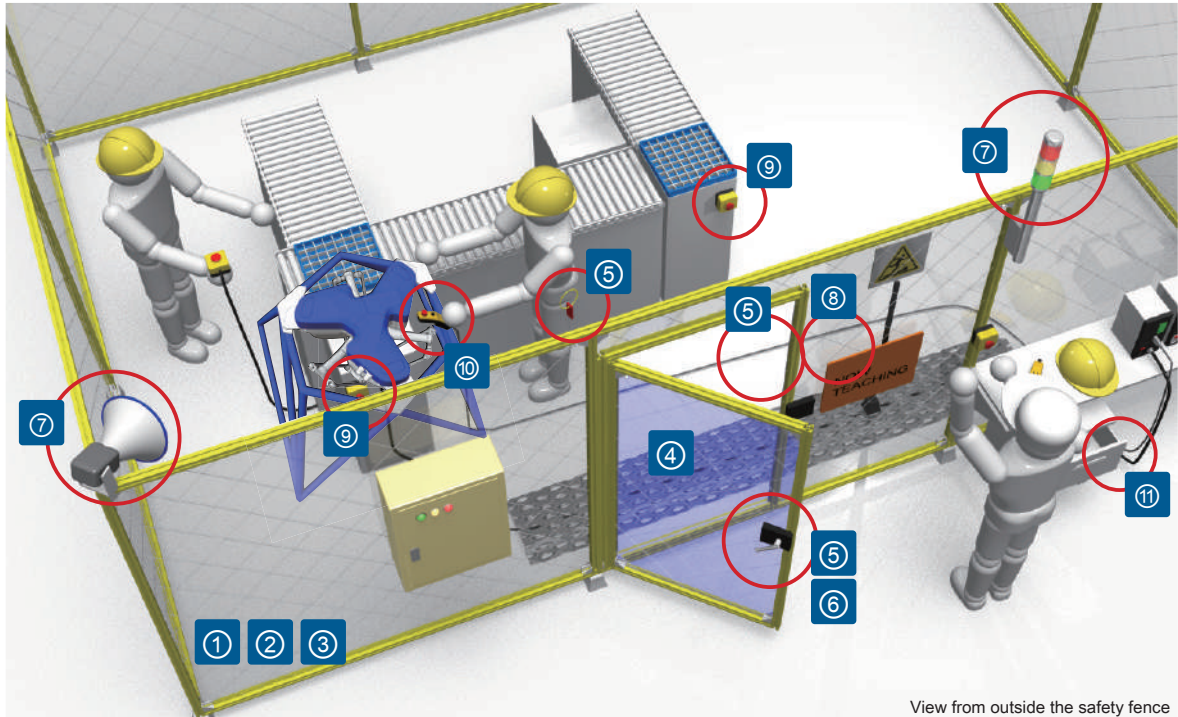

#### Tips

- ① The safeguarding must be configured such that the operator can monitor the manipulator movements from outside the safety fence.
- ② The safeguarding material must be robust - not easily be moved, broken down or deformed.
- ③ Even if the manipulator throws out the workpiece, the safeguarding structure must contain the workpiece inside.
- ④ No entry other than through the designated entrance/exit.
- ⑤ The gate must be tagged out and locked out with a safety plug or a door switch. The operators must carry the safety plug when entering the safeguarded area.  
Connect the output contacts of safety plug and door switch to the safety connectors EMS2.
- ⑥ Install an interlock which will work for the entire system.
- ⑦ Install alarm signal lights and alarm sound equipment.
- ⑧ The operators should be able to signal each other.
- ⑨ Installing one or more emergency stop switches inside the safety fence.  
Install emergency stop switches such that the operator can easily stop the manipulator in the event of emergency.
- ⑩ The JOG stick or teaching pendant must be operated from outside the work envelop of the manipulator.
- ⑪ Remove the JOG stick or teaching pendant from the controller whenever the operation is complete.  
Keep the JOG stick or teaching pendant in a locked place so that no one except the operator can change the operation mode.

## Safety Measures

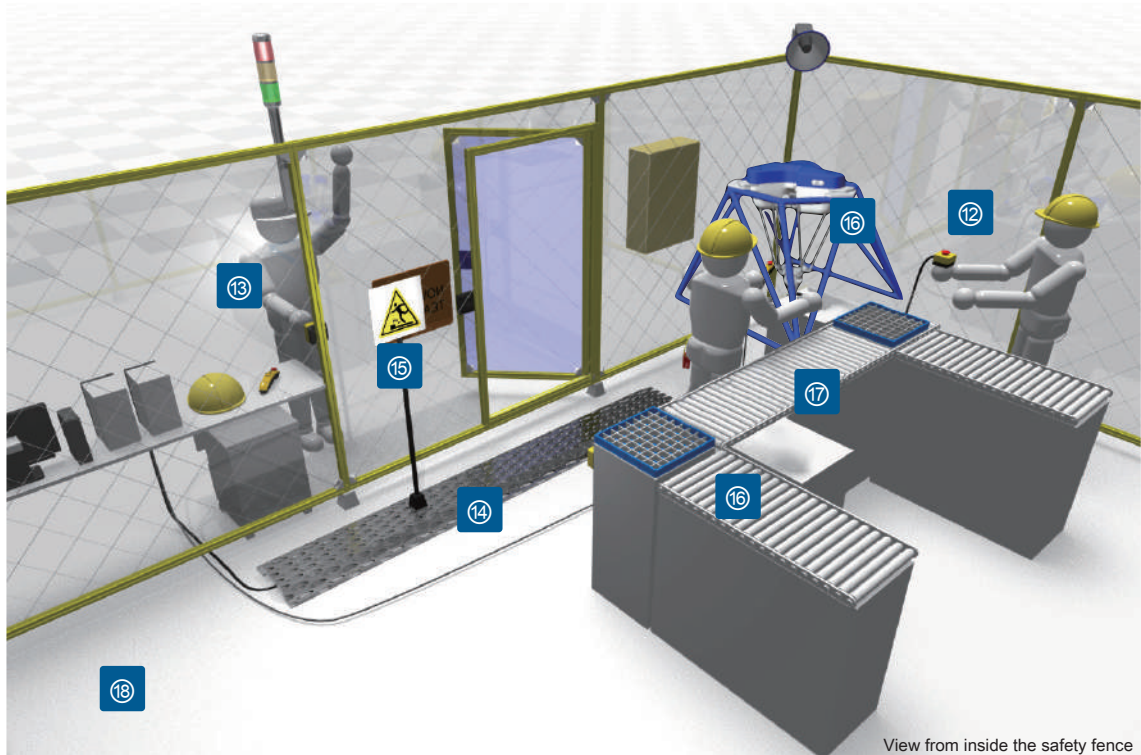

View from inside the safety fence

### Tips

- ⑫ Any personnel accompanying the operator should carry a portable emergency stop switch.
- ⑬ While monitoring the operation closely, the watchdog must be ready to press the emergency stop switch at any moment when needed.
- ⑭ Protect wiring and piping with a cover or any other means.  
Take preventive measures against disconnection or damage of wires and pipes and trip/fall hazards.
- ⑮ Place hazard warning signs at high places and uneven surface areas.
- ⑯ Confirm that there is no interfering of peripherals nor obstacles in the work envelope of manipulator.
- ⑰ Secure adequate spaces that facilitate safe work of teaching and maintenance.
- ⑱ Maintain adequate lighting for safe work.

# Safety Measures



## 3. Occupational Safety and Health Training

### Occupational Safety and Health Training

This product is classified as "industrial robots" defined by the Occupational Safety and Health Act in Korea. Any business entities who use this product are required to provide training on industrial robots to their workers engaging to work with the product or its applications.

#### 1. Contents of the Mandatory Training

A training program (classroom lectures and practical training) covering the work that personnel will be engaged in, as stipulated by Special safety and health training for robot operation.

The practical training should cover procedures in the event of abnormalities.

#### 2. Instructor Qualification

Expertise knowledge and experience on the subjects which is system integrators, occupational safety consultants, qualified employees, or other specialists, who have in-depth knowledge on industrial robots which is specialized institutions entrusted with safety and health education or stipulated by Occupational Safety and Health Act article 33, paragraph 3

#### 3. Recording the Education

Keep a record regarding the training program offered, including the trainee names, subjects, and training topics for at least 3 years.

### ■ Occupational Safety and Health Act Enforcement Rule [ table 8] < Revised at 2018. 3. 30.>

#### Duration of Occupational Safety and Health Training

##### 1. Occupational Safety and Health Training ( from article 33, paragraph 1 )

Curriculum	Subject	Duration
D. Special Training	Employees engaged in any of the specified jobs except daily employee	- 16 hours or more (more than 4 hours before the work, and 12 hours can be divided within 3 months) - 2 hours or more for short-term or intermittent operations.

### ■ Occupational Safety and Health Act Enforcement Rule [table 8-2] < Revised at 2018. 3. 30.>

#### Training details by training subject

##### 1. Employee( from article 33, paragraph 1 )

##### D. Training contents for safety and health training by operation

Operation	Training
37. Robot Operation	<ul style="list-style-type: none"> <li>○ Issues concerning the basic principles, structure, and working methods of robots</li> <li>○ Issues concerning emergency measures in the event of an abnormality</li> <li>○ Issues concerning safety facilities and safety standards</li> <li>○ Issues concerning the operation method and the sequence of operations</li> </ul>

##### 4. Training of Inspectors contents ( from article 43, paragraph 2 )

Facility	Curriculum	Content
Industrial robots	Foster training	<ul style="list-style-type: none"> <li>○ Related Acts and regulations</li> <li>○ Introduction to Industrial Robots</li> <li>○ Industrial robot structure and characteristics</li> <li>○ Inspection criteria</li> <li>○ Protective device</li> <li>○ Application and method of use of inspection equipment</li> <li>○ Inspection practice and checklist preparation tips</li> </ul>





## Safety Measures

### ZERO robot training course

This product is classified as "industrial robots" defined by the 'Occupational Safety and Health Training ' from Occupational Safety and Health Act in Korea.  
Any business entities who use this product are required to provide training on industrial robots, as stipulated by applicable laws of each country, to their workers engaging to work with the product or its applications.

Application	Please apply by our e-mail or phone. E-mail : zero@globalzeus.com TEL : 031-5187-1000~1
Privacy Policy	The Company will use the collected personal information for the purpose of delivery of information on services and product by established privacy policy.
Location	ZEUS Co., LTD headquarters 132, Anyeongnam-ro, Hwaseong-si, Gyeonggi-do, South Korea
Service Inquiries	ZEUS Co., LTD Factory Automation Business Department E-mail : zero@globalzeus.com TEL : 031-5187-1000~1
Certificate of Completion	Will issue a certificate of completion at the end of the course.
Subject	Individual applications and classes are not accepted for business-oriented courses. This course is for customers who purchased "ZERO". Please refer to each course for other qualifications.

## 1. Basic Course( 2 days )

Subject	It is a basic course to learn basic behavior and teaching of industrial robots. A person engaged in robot work using this product
Robot Model	ZRB-****N-***
Day 1	<ul style="list-style-type: none"> <li>· Related Acts and regulations</li> <li>· About safety</li> <li>· Knowledge of industrial robots</li> <li>· Knowledge of operations, such as teaching, etc.</li> <li>· How the robot operates</li> <li>· Methods of operations, such as teaching, etc.</li> <li>· Set operation speed</li> <li>· Basic Programming 1</li> </ul>
Day 2	<ul style="list-style-type: none"> <li>· Basic Programming 2</li> <li>· JOG Stick</li> <li>· Advanced programming</li> <li>· File management</li> </ul>

## 5. Maintenance and Inspection



For safe use of the product, perform daily and periodic inspections. If there is a problem, immediately repair the robot or apply appropriate remedies in order to prevent robot failures and ensure safety.

Perform inspection and maintenance from outside the work envelop.

If that's not possible, take safety measures first. Inspection and maintenance on the entire system must be carried out by designated personnel who have been trained according to the integrator's maintenance plans.

Do not conduct insulation resistance testing (Megger testing).

Observe the following before starting maintenance and inspection.

1. Post a sign such as "Inspection in Progress" in order to prevent other personnel from operating the robot inadvertently.
2. Lock out the controller. The service worker should carry the key in order to be the only person to have access to the controller.
3. Secure sufficient space and lighting for inspection work.
4. Only qualified personnel who completed the industrial robot training are allowed to service inspection.
5. Place a watchdog to be responsible monitoring the entire system closely and be ready to trigger an emergency stop at any moment when needed.
6. The supervisor and the maintenance person must confirm the way of signaling to each other.
7. If any repairs have been made, keep the record of the repairs for at least three years.

---

### Bolts/Screws and Torque Tightening

Size	Torque Tightening (N·m) (1.8T, vehicle/engine use)
M3	1.14
M4	2.7
M5	5.4
M8	22.0





# Maintenance and Inspection

## 1. Daily Checkup

Check the following items every day before starting operation.

### Before turning on the power

Check Items	Description	What to do in the event of an abnormality
Emergency Stop Switches	1. Do the emergency stop switches work properly?	Do not start inspection until all E-stop switches are confirmed to work properly.
Controller	2. Is the power cable tightly connected?	Ensure a good connection.
	3. Are the I/O connector and the safety connector firmly connected?	Ensure a good connection.
	4. Are any foreign materials such as oil or any other liquids, or dust present on the connectors at the front? (conductive or flammable materials)	Remove any foreign materials.
	5. Are there any dust or debris blocking the exhaust (or intake) vent(s)?	Remove any foreign materials.
	6. Is the manipulator cable plugged into the jack all the way and locked?	Ensure a good connection. The cable coming off during operation can cause unpredicted movements.
	7. Are any of the mounting bolts loosened?	Confirm that they are all tightened with the rated torque.
	8. Are any of the screws or fixing mechanism loosened?	Confirm that they are all tightened with the rated torque.
	9. Are there no signs of chaps or cracks on the resin parts?	Contact customer service center.



## Maintenance and Inspection

### Before turning on the power

Check Items	Description	What to do in the event of an abnormality
Manipulator	10. Are any foreign materials such as powder or oil present on the surface?	Remove any foreign materials.
	11. Are there interfering objects or obstacles in the work envelope?	Move any interfering objects and obstacles out of the work envelope.
JOG Stick	12. Are there any signs of chaps or cracks?	Replace jog stick with which has no chaps or cracks.
	13. Do the enable switch and the E-stop switch work properly?	Do not use the JOG stick having a faulty switch.
Teaching Pendant	14. Are there any signs of chaps or cracks?	Replace teaching pendant with which has no chaps or cracks.
	15. Do the enable switch and the E-stop switch work properly?	Do not use the teaching pendant having a faulty switch.
Cables	16. Are any of the cable jackets torn nor scratched?	Use cables which have no wears and scratches.
	17. Is there any water, oil or other liquid on any of the cables?	Thoroughly remove oil, water, or other liquid from the cables.
Safety Barriers and Peripheral Equipment The Overall System	18. Are there any visible problems or abnormal conditions in the system? Are there any loosened connections between equipment/devices or dislocations?	Take appropriate measures in accordance with the SOP.
Power Supply	19. Is the power supply normal and stable? Is the power supply voltage normal?	Repairs must be performed by a qualified electrician in accordance with the SOP.
Installation Environment	20. Do the operating conditions meet the installation requirements? Are there any changes made in the environment since the installation?	Reevaluate and adjust the conditions until the requirements are met.
Other Items Including Joints and End-Effectors	21. Are there any foreign materials caught in the moving parts of the robot?	



## Maintenance and Inspection

### When Turning on the Power

Check Items	Description	What to do in the event of an abnormality
Controller	1. Are there any unusual noise or smell?	Are any foreign materials inside the controller? If there are unusual noise or smell with no sign of foreign materials, please contact the customer service. Never attempt to disassemble the controller.
Manipulator	2. During jogging operation, are there any abnormal motion, noise or smell?	If any, contact the customer service.
Emergency Stop Switches Enable switch (Jog stick and teaching pendant)	3. Are the switches working? Do the manipulator and the peripherals synchronized with it stop immediately?	Do not use any faulty switch, JOG stick or teaching pendant.
Interlocks	4. Is the locking mechanism working? Do the manipulator and its peripherals stop operating when the safety gate opens?	Follow the instructions from the supervisor.

### Test-run of the Robot

Test run the robot using the motion program at reduced speed.

Check Items	Description	What to do in the event of an abnormality
Controller	1. Did the 7-segment LED show 「run」 ? (indicating "executing the user program")	If 「run」 does not appear after you restart it, please contact the customer service. Never attempt to disassemble the controller.
Manipulator	2. Operate the robot at reduced speed.(slower than 250 ms) Is there any positional aberration of the manipulator motion?	Are any of the mounting bolts loosened? Are any of the mounting screws on the top flange loosened? Are any of the robot fixtures out of place?
	3. When being operated by user program, is the manipulator moving abnormally or causing abnormal noise?	Follow the instructions from the system administrator.

## Maintenance and Inspection



### 2. Periodic Inspection

Conduct periodic inspection at least once a month in addition to the daily checkups.

Estimate of operating hours to determine inspection cycle (only for reference):  
 15 hours/day x 20 days/month x 3 months = approximately 1,000 hours

Check Items	Description	What to do in the event of an abnormality
Controller	1. Is the air filter dirty or clogged? (visual check)	Clean or replace the air filter. Never disassemble the controller.
Manipulator	2. Are any of the bolts or screws loosened?	Screw them all tightly.
Connector fixing screw Terminal block screws	3. Are any of the screws loosened?	Screw them all tightly.
Joint unit (speed reducer)	4. Are there any unusual noise or smell?	Contact customer service center.
Teaching Pendant	5. Are there any unusual noise from speaker?	Contact customer service center.
Teaching Pendant	6. Is the air filter dirty or clogged?	Contact customer service center.

## 6. Compliance with International Standards



### 1. Relevant Standards

Standard		Manipulator	Controller
ISO			
KCs			
EC	Low Voltage Directives		
	EMC		
	Machinery Directive		
RoHS			
UL			
CSA			
JIS			
CCC			

Compliance with International Standards

### 2. Environmental Standards

Standard		Manipulator	Controller
IP		IP40	IP2X
Cleanroom		ISO Class 3	
Vibration and shock			IEC 61131-2

## 7. Exportation Control



- If you are to export (or offer to a non-resident) the Product or its technical documentation, comply with Korean and any relevant country-specific laws and regulations regarding foreign trade security control.
- May not provide the Product or its technical documentation if you are in violation of the relevant laws or regulations.
- At the time of the Product export or provision to non-residents, you must comply with the Foreign Exchange and Foreign Trade Act and its related laws (such as the Foreign Exchange Act), and with Export Administration Regulations ( "EAR" ) in the U.S., and work through an appropriate process such as obtaining an export permit.  
In case of export illegally without obtaining the necessary permission, you may be subject to criminal or administrative sanctions under the law.
- When using wooden pallets, check the International Trade Regulations for wood packaging materials (ISPM No.15).



## 8. Warranty and Disclaimer

### 1. Warranty

#### Definitions (wherever capitalized in this agreement)

ZEUS	ZEUS CO., LTD.
Product Documentation	Documentation regarding the ZEUS Product such as catalogs, the specifications, the user's guides, and other manuals. This includes those provided in electronic form.
Terms of Use	In connection with the ZEUS Product, terms and conditions of use, specifications, product features, operating environment, operating procedures, precautions, and so on which are described in the Product Documentation.
Customer Application	Any use by you of the ZEUS Product These include customer-made parts, circuitry, equipment, machinery, or systems in which the Product is installed or used by you.
Fitness	The following items in connection with the Customer Application: <ul style="list-style-type: none"> <li>a. fitness for a particular purpose,</li> <li>b. performance,</li> <li>c. non-infringement of intellectual property rights of any third party,</li> <li>d. compliance with laws and regulations, and</li> <li>e. compliance with any relevant standards.</li> </ul>

#### Warranty Period

ONE(1) year from the date of purchase

The standard Warranty Period may be modified through a special agreement with ZEUS.

Conduct an inspection upon receipt of the delivery. Notify us in writing within one week if there are any problems. If not notified, we consider that the delivered product passed your inspection.

#### Warranty Services

If any ZEUS Product defect arises within the Warranty Period, ZEUS will do one of the following free of charge:

- (1) repair the defect (except for mechanical and electrical components),
- (2) exchange the product with a product which is functionally equivalent to the original product.

After the Warranty Period expires, any repair services by ZEUS will be fee-based.

#### Application of Warranty

The Warranty applies only to the Products directly purchased from ZEUS.

No warranty applies to Product that has been resold or transferred to a third party, or installed or relocated overseas.

#### Subject to Warranty

The Warranty covers the delivered Product only.

Any programs and internal data (such as points) created or modified by the user are not covered by the Warranty.

In addition, any secondary damages such as damage to other user-owned equipment, opportunity cost, or lost profits, resulting from failure or fault of the Product are not covered by the Warranty.



## Warranty and Disclaimer

### Disclaimer of Liability

Product failure caused by any of the following reasons will void your warranty

- a. Unintended Use of the Product.
- b. Use of the Product not mentioned in Terms of Use.
- c. Use of the Product which does not comply with "Precautions for Use."
- d. Products altered, disassembled, repaired, or changed to unrated by anyone other than ZEUS.
- e. Use of any application software other than those specified by ZEUS.
- f. Failure due to reasons that ZEUS was unable to anticipate from the scientific or technological standards available at the time of shipment.
- g. External cause which the Product is not liable for. This includes, but is not limited to, misfortunes, such as pollution, collision or fall, natural disaster, and fire.
- h. Deterioration or fault by due to aging.
- i. Wear and tear caused by normal usage.

ZEUS shall assume no liability for claims if any of the following conditions is present:

- j. The claim is limited to perceptive phenomena such as motion noises or vibrations that affect neither the product quality nor functionality.
- k. The product serial number or the date of manufacture is unidentifiable or unreadable.
- i. ZEUS is unable to repeat claimed failure or specify its primary reasons.

### Precaution on the Documentation

Specification values (such as ratings and performance measurement) were obtained in separate tests under independent conditions and are not guaranteed under all user conditions.

Use cases are not guarantee the suitability of the product for the customer's use.

ZEUS may discontinue production of the Product or change its specifications, due to product initiatives or any other reasons.





## Warranty and Disclaimer

### Precautions on Use of the Product

Users must comply with Terms of Use.

Users are responsible for determining Fitness and the usability of the Product.  
ZEUS disclaims any implied warranty of Fitness.

Users are responsible for verifying in advance that wiring, connections and installations are appropriate for intended use of the Product in user's overall system.

For safe use of the product, you must take the following precautionary measures.

- ① Usage not exceeding specification and performance limits of the Product; and design usage with redundancy for safety
- ② Design for safety, in order to minimize risk to Customer Application in case of Product failure
- ③ Safety design of the overall system in order to prevent hazards and alert users
- ④ Regular maintenance and inspection of the Product and the Customer Application

The product is designed and manufactured, and intended for general industrial use.

Warranty does not apply to any residential use of the Product, nor to other unintended uses of the Product including – but not limited to – the following examples:

① Applications for military activities or weapons

Usage where the end user or applications of the product is involved in military activities or weapons

② Applications that require a high level of safety

Nuclear power control facilities, combustion facilities, aviation and aerospace facilities, railway facilities, vessel manufacturing/loading facilities, elevating facilities, recreational facilities, medical equipment, safety devices, automotive manufacturing/loading equipment, or life-threatening usage

③ Applications that require a high degree of reliability

Gas/water/electricity supply system, communications system, financial system, payment system, right/asset management system, or any 24/7 operating system

④ Usage under harsh conditions or environments

Facilities installed outdoor, or facilities subject to chemical contamination, electromagnetic disturbance, vibrations/impact, or dust, underground mining site

⑤ Usage under conditions or environments that are not described in the Product Documentation

ZEUS shall not be liable for any incident resulting in death or serious injury, property loss, or product failure, if you did not observe precautions and warnings described in Terms of Use.

ZEUS can not necessarily anticipate all conditions for possible risk and suboptimal outcomes.

Warnings, cautions, and other matters described in Terms of Use are within the scope reasonably anticipated by ZEUS.

## Warranty and Disclaimer

---



### 2. Disclaimer of Liability

---

ZEUS assumes no responsibility for secondary damages (including, but not limited to damage to equipment, opportunity cost, or lost profits) that may have been caused in connection with use of the Product.

ZEUS shall not be liable for compensation claim by any third party for any product that was manufactured using the Product. This includes, but is not limited to, claims, where the reasons are infringement of patent/intellectual property or any other rights.

Neither industrial property rights are guaranteed nor license is granted by this document. In addition, ZEUS assumes no responsibility for any issues concerning the industrial property rights, which the contents of this document can cause.

#### Prohibition of Robot Modifications

---

Do not modify any of the manipulator, the controller, JOG stick, nor the teaching pendant.

Warranty does not apply to any robot or its component that has been modified, or secondary damages caused by the modification.

#### Robot Relocation, Transfer, or Resale

---

- When relocating, transferring, or reselling the robot, please hand over all the Product Documentation to the new owner of the robot.
- The new owner has to comply with the safety laws and regulations, create a SOP, and provide personnel with the required education and training on industrial robotics.
- No warranty shall apply to the Product that has been resold or transferred to a third party, or installed or relocated overseas.
- When repacking the Product, use the packaging material used at the time of the delivery, and follow the steps in reverse order of unpacking. Not observing this will void the warranty.

#### Disposal Method

---

- Dispose of the product as industrial waste and packing materials separately according to the material, in accordance with the applicable national and local laws, regulations, and standards.
- Without dismantling, dispose of the electrolytic capacitor as industrial waste.
- ZEUS does not offer a collection service.
- Attach a name tag to the product to show what it is if necessary.

## 9. Declarations and Certificates



### 자율안전확인 신고증명서

신청인	사업장명	(주)제우스	사업장관리번호	229-81-053230
	사업자등록번호	229-81-05323	대표자 성명	이종우
	소재지	(18363) 경기도 화성시 안녕남로 132		
자율안전인증대상 기계·기구명		산업용로봇		
형식(규격)	ZRC-0306N	용량(등급)	3 axis	
자율안전확인번호	22-AH1EQ-00211			
제조사	(주)제우스			
소재지	(18363) 경기도 화성시 안녕남로 132			

「산업안전보건법」 제89조제1항 및 같은 법 시행규칙 제120조제3항에 따라  
자율안전확인 신고증명서를 발급합니다.

2022년 01월 24일

한국산업안전보건공단 이사장





### 자율안전확인 신고증명서

신청인	사업장명	(주)제우스	사업장관리번호	229-81-053230
	사업자등록번호	229-81-05323	대표자 성명	이중우
	소재지	(18363) 경기도 화성시 안녕남로 132		
자율안전인증대상 기계·기구명		산업용로봇		
형식(규격)	ZRC-0306R	용량(등급)	4 axis	
자율안전확인번호	21-AH1EQ-02115			
제조사	(주)제우스			
소재지	(18363) 경기도 화성시 안녕남로 132			

「산업안전보건법」 제89조제1항 및 같은 법 시행규칙 제120조제3항에 따라 자율안전확인 신고증명서를 발급합니다.

2021년 10월 27일

한국산업안전보건공단 이사장











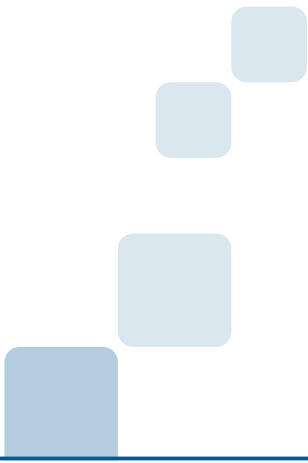

Customer service center

ZEUS : 132, Anyeongnam-ro, Hwaseong-si, Gyeonggi-do, South Korea

e-mail : [zero@globalzeus.com](mailto:zero@globalzeus.com)